



# Alfa Laval Koltek Valves

## Shutter valves

### Introduction

The Alfa Laval Koltek Valve can be either manually or pneumatically operated. The valve is suitable for use with products that are highly viscous, contain large particles, or have strict requirements to minimize pressure loss.

### Application

The koltek valve is designed for use in the food, chemical, pharmaceutical and many other industries.

### Benefits

- Flexible in-line valve with three-port flow diversion
- Minimized pressure loss
- Hygienic design
- Capable of handling products highly viscous, contain large particles, or have strict requirements to minimize pressure loss

### Standard design

The koltek valve consists of a rigid body with an internal cylindrical bore, a PTFE shutter and three ports for pipe connection. The two lids have guide rings or bearings for an internal shaft, which supports and positions the shutter. The stainless-steel handle for manual operation or the actuator for automatic operation is fitted to turn the shaft. The actuator consists of a system of cylinders and one or two main pistons interconnected with a toothed bar which interacts with a gear wheel on the valve shaft. The system is insensitive to pressure shocks in the valve.

### Working principle

The Alfa Laval Koltek Valve is operated by means of a handle or an actuator. A spring system presses the shutter against the inside cylindrical surface of the valve body thus ensuring complete tightness.

The air-actuated valve can be fitted with an Alfa Laval ThinkTop® V50 or V70 control unit, or an indication unit installed laterally for remote indication of the valve position.

The manually operated valve can be fitted with indication units (used for Alfa Laval LKLA actuators) installed laterally. The valve actuator is available in two versions: a single-acting actuator or a double-acting actuator. The single-acting actuator operates with one main piston whereas the double-acting actuator operates with two main pistons.



## TECHNICAL DATA

Temperature	
Max. temperature:	110°C
Pressure	
Max. pressure against shutter:	300 kPa (3 bar)
Max. pressure behind shutter:	1000 kPa (10 bar)
Air pressure for actuator:	Max. 800 kPa (8 bar) Min. 500 kPa (5 bar)

### Air Connections

#### Compressed air:

R 1/8" (BSP), internal thread

## PHYSICAL DATA

Materials	
Product wetted steel parts:	1.4404 (316L)
Product wetted seals:	Shutter in PTFE EPDM
Actuator seals:	NBR

### Actuator functions

#### Actuator type 630:

- for 25 mm to 76.1 mm valves only
- two positions
- spring/air
- turning angle 1x90°

#### Sizes 12.7-51mm/DN25-50:

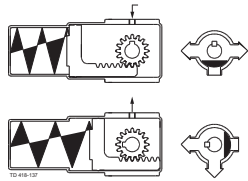

#### Sizes 63.5-76.1mm/DN65:

#### Double acting actuator

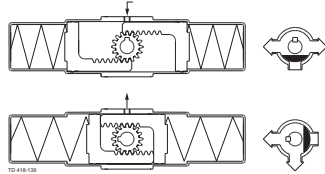

#### Actuator type 631:

- two positions
- air/air
- turning angle 1x90°

#### Sizes 12.7-76.1mm/DN25-65:

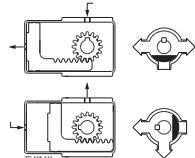

### Pneumatic connections

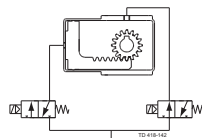
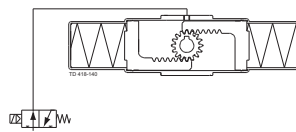
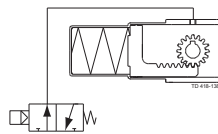

**Sizes 101.6mm/DN80100:**

**Double acting actuator**

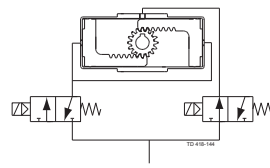
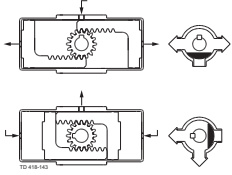

**Actuator type 632:**

- two positions
- air/air
- turning angle 1x180°

**Sizes 12.7-76.1mm/DN25-65:**

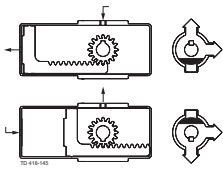

**Sizes 101.6mm/DN80100:**

**Double acting actuator**

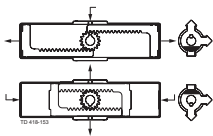

**Actuator type 633:**

- three positions
- air/air
- turning angles 2x90°

**Sizes 12.7-76.1mm/DN25-65:**

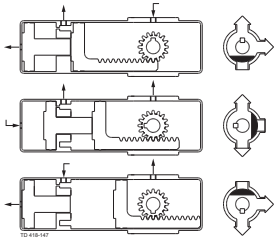

**Pneumatic connections**

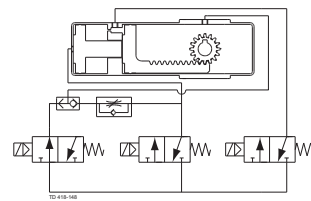
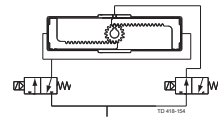
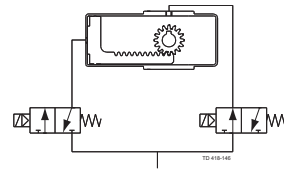

## Dimensions (mm)

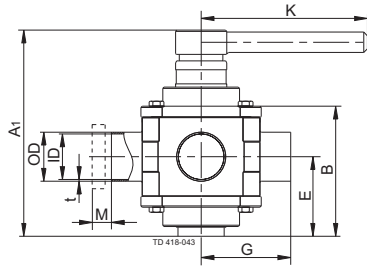

a. MH53 with handle.

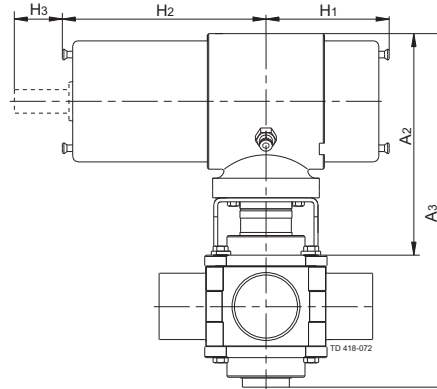

b. MH53 with actuator, type KH631.

Fig. 1. Dimensions.

## valves:

Size	25	38	51	63.5	76.1	101.6	25	40	50	65	80	100
	mm	mm	mm	mm	mm	mm	DN	DN	DN	DN	DN	DN
A <sub>1</sub>	116	149	161	179	204	292	116	150	161	204	272	292
B	65	90	102	118	137	195	65	90	102	137	174	195
OD	25.4	38.1	50.8	63.5	76	101.6	29	41	53	70	85	104
ID	22.1	34.8	47.5	60.2	72	97.6	26	38	50	66	81	100
t	1.65	1.65	1.65	1.65	2	2	1.5	1.5	1.5	2	2	2
E	42	56	62	70	80	117	42	56	62	80	107	117
G	55	70	82	105	110	155	64.5	80	82.5	100.5	115.5	130.5
K	130	130	180	180	235	330	130	130	180	235	330	330
M/DIN male							22	22	23	25	25	30
M/SMS male	15	20	20	24	24	35						
Weight (kg)	1.8	3.3	4.8	6.9	10.5	25.0	1.8	3.3	4.8	10.5	22.0	25.0

## Actuators

Size		25mm	38mm	51mm	63.5mm	76.1mm	89mm	101.6mm
		DN25	DN40	DN50		DN65	DN80	DN100
A <sub>2</sub>		170	170	170	172	178	194	194
A <sub>3</sub>		233	260	273	290	315	369	389
H <sub>1</sub>	KH630	57	57	57	285	285		
H <sub>1</sub>	KH631	57	57	57	57	57	119	119
H <sub>1</sub>	KH632	95	95	95	95	95	194	194
H <sub>1</sub>	KH633	95	95	95	95	95	281	281
H <sub>2</sub>	KH630	326	326	326	285	285		
H <sub>2</sub>	KH631	119	119	119	119	119	119	119
H <sub>2</sub>	KH632	157	157	157	157	157	194	194
H <sub>2</sub>	KH633	243	243	243	243	243	281	281
H <sub>3</sub>		43	43	43	43	43	43	43

## Caution, opening/closing time:

Opening/closing time will be affected by the following:

- The air supply (air pressure).
- The length and dimensions of the air hoses.
- Number of valves connected to the same air hose.
- Use of single solenoid valve for serial connected air actuator functions.
- Product pressure.

## Pressure drop/capacity diagrams

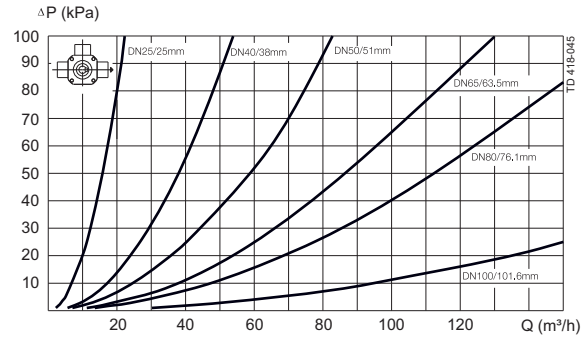
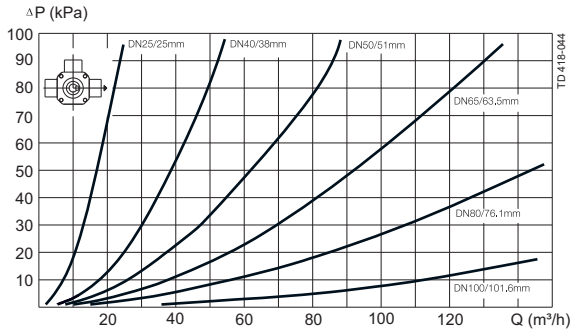

### Note!

For the diagram the following applies:

Medium: Water (20°C).

Measurement: In accordance with VDI 2173

Pressure drop can also be calculated in Anytime configurator.

Pressure drop can also be calculated with the following formula:

$$Q = K_v \times \sqrt{\Delta p}$$

Where

Q = Flow in m<sup>3</sup>/h.

K<sub>v</sub> = m<sup>3</sup>/h at a pressure drop of 1 bar (see table above).

Δ p = Pressure drop in bar over the valve.

How to calculate the pressure drop for an ISO 2.5" shut-off valve if the flow is 40 m<sup>3</sup>/h

2.5" shut-off valve, where K<sub>v</sub> = 111 (See table above).

$$Q = K_v \times \sqrt{\Delta p}$$

$$40 = 111 \times \sqrt{\Delta p}$$

$$\Delta p = \left(\frac{40}{111}\right)^2 = 0.13 \text{ bar}$$

(This is approx. the same pressure drop by reading the y-axis above)

### Options

- A. Male parts or clamp liners in accordance with required standard.
- B. Control and Indication: IndiTop, ThinkTop or ThinkTop Basic.
- C. Bottom lid for hot water or steam heating.
- D. Bottom fitted indication unit.
- E. Limit stop for MH 52/53.
- F. Pilot valve, type L or T (for actuator type 633). Type L is used when two ThinkTop units are used.
- G. Rebuilding to double acting valve for high viscosity product or quick operation.

### Note!

For further details, see also instruction IM 70735.

### Bottom fitted indication units\*

(together with bracket for indication unit)

	Actuator type			
Indication unit	KH630	KH631	KH632	KH633
LKLA (lateral indication unit)	1 pcs.	1 pcs.	2 pcs.**	2 pcs.**

\*) Not possible in combination with heated lid.

\*\*) Not suitable for micro switch.

**Note!** For all manually operated valves: Use LKLA indication units.



Alfa Laval reserves the right to change specifications without prior notification.

---

**How to contact Alfa Laval**

Contact details for all countries are continually updated on our website. Please visit [www.alfalaval.com](http://www.alfalaval.com) to access the information direct.