



Alfa Laval SMP-BC

Double seal valves

Introduction

The Alfa Laval SMP-BC Mixproof Valve is a hygienic pneumatic double-seal valve that safely handles the simultaneous flow of two different products through the same valve without any risk of cross-contamination. Standardized and cost-effective, the top-loaded valve is designed for quick leakage detection to maximize product safety and low maintenance due to few moving parts. It is often used in Cleaning-in-Place (CIP) lines and can also be used in other systems handling products.

Application

The Alfa Laval SMP-BC Mixproof Valve is designed for hygienic applications that require additional safety, leakage detection and CIP in the dairy, food and beverage, personal care and many other industries.

Benefits

- Hygienic double-seal mixproof valve
- Versatile, modular design meets most hygienic application requirements
- Cost effective

Working principle

The Alfa Laval SMP-BC Mixproof Valve is controlled by means of compressed air from a remote location. The valve is fitted with two small pneumatic normally open (NO) valves, a detecting valve and a CIP valve. The valve plug has two seals, which form an atmospheric leakage chamber. Any product leakage is discharged through the detecting valve. The leakage chamber may be cleaned by supplying a CIP system into the detecting valve. The SMP-BC is insensitive to water hammer in the product line above the plug.



Standard design

The Alfa Laval SMP-BC Mixproof Valve consists of valve bodies, bonnet, plug and an actuator. Two versions are available: a shut-off valve with one valve body and a shut-off valve with two valve bodies. A plug clip system and clamp rings secure the valve bodies to the actuator. The valve can also be fitted with the Alfa Laval ThinkTop V50 and V70 for sensing and control of the valve.

TECHNICAL DATA

Pressure

Max. product pressure (depending on valve specifications):	1000 kPa (10 bar)
Min. product pressure:	Full vacuum
Air pressure:	500 to 800 kPa (5 to 8 bar)

Temperature

Temperature range:	-10°C to +140°C (EPDM)
--------------------	------------------------

PHYSICAL DATA

Material

Product wetted steel parts:	1.4401 (316L)
External surface finish	Semi-bright (blasted)
Internal surface finish	$Ra \leq 1.6 \mu m$
Optional:	Bright Polished $Ra \leq 0.8 \mu m$
Other steel parts:	1.4301 (304)
Product wetted seals:	EPDM (optional: NBR, FPM)
Other seals:	NBR

Valve body combination

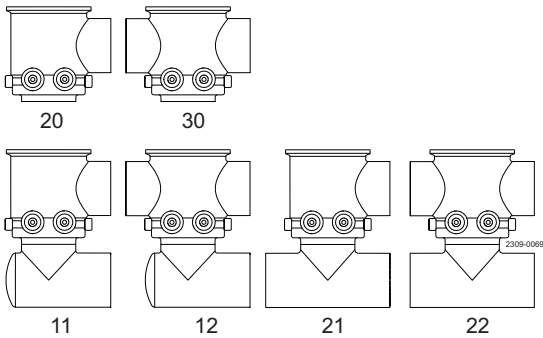

Type 20 and 30 body versions are on request available in following configurations:

- Tee welded on lower port in 0 or 90 deg. version. Type: 21 and 22
- Bend welded on lower port in 0, 90, 180 or 270 deg. version. Type: 11 and 12

Options

- A. Male parts or clamp liners in accordance with required standard.
- B. Control and Indication: ThinkTop V50 and V70, IndiTop.
- C. Actuator with stronger spring.
- D. Larger actuator for valve sizes 38-51 mm/DN40-50.
- E. CIP installation kits.
- F. Other valve body combinations.
- G. Service tools for actuator.
- H. Tool for plug seals (Necessary for changing the seals).

Note!

For further details, see also instruction manual ESE02255.

Air consumption (litres free air) for one stroke

Size	38-51 mm DN 40-50	63.5101.6 mm DN 65100	DN 125-150	DN 125-150
Stop valve	0.2 x air pressure (bar)	0.7 x air pressure (bar)	1.5 x air pressure (bar)	2.2 x air pressure (bar)
Actuator function	NC	NC	NC	NC
Stop valve			3.6 x air pressure (bar)	2.9 x air pressure (bar)
Actuator function			NC (Support air for closing)	NC (Support air for opening)

Operation/cleaning

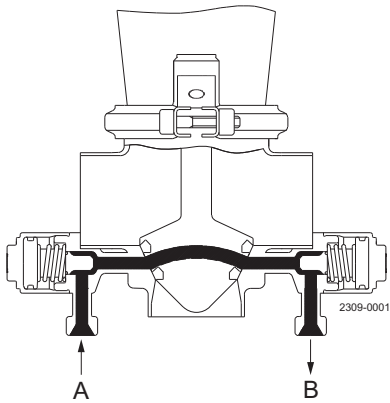

a. Closed shut-off valve:
Cleaning of the leakage
chamber.

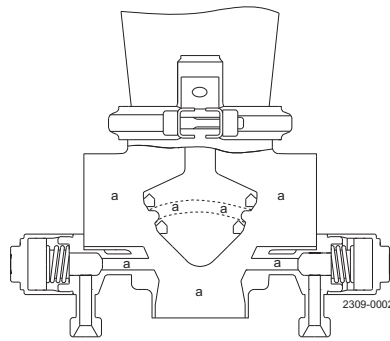

b. Open shut-off valve
a. Cleaning of the valve body and
the leakage chamber.

Pressure drop/capacity diagrams

Shut-off valve:

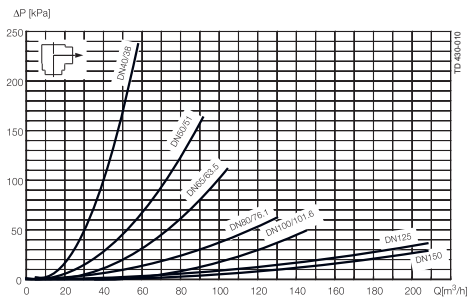
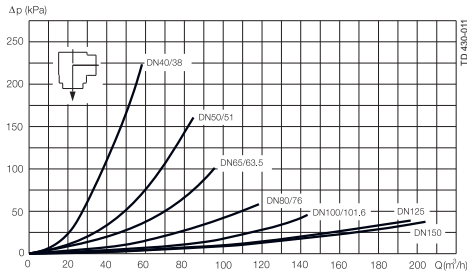
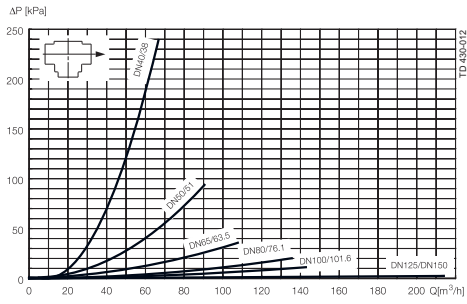

Leakage chamber, pressure drop and flow velocity.

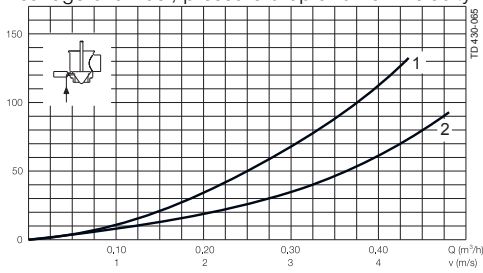

- 1) CIP/detecting valve $\varnothing 27$
- 2) CIP/detecting valve $\varnothing 32$

Change-over valve, (obsolete products):

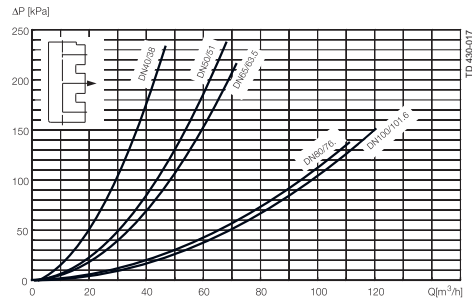
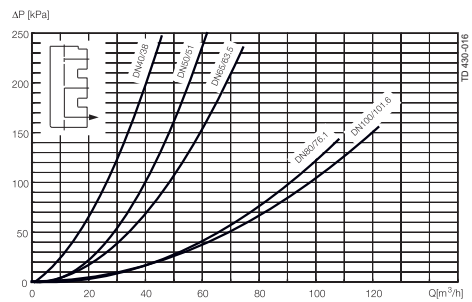
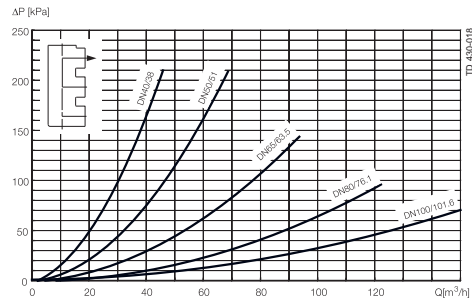
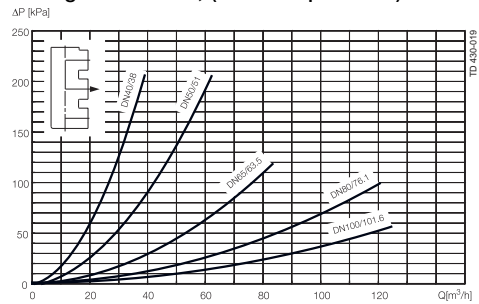

Note! For the diagrams the following applies:
Medium: Water (20°C).

Measurement: In accordance with VDI 2173.

Max pressure difference/support air pressure diagrams

Upper plug max. product pressure without leakage, as a function of support air:

ø89 Actuator

Support air P_{air} [bar]

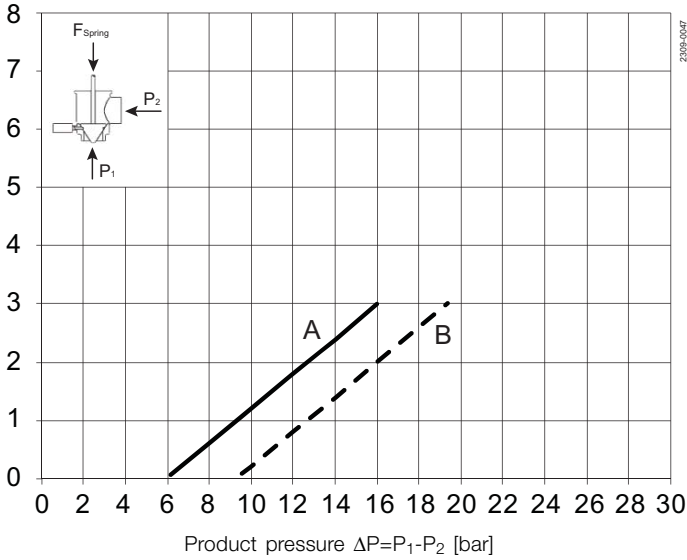

- A. ø89 std. spring; DN40/DN50; ISO38/ISO51
- B. ø89 strong. spring; DN40/DN50; ISO38/ISO51

ø133 actuator with standard spring

Support air P_{air} [bar]

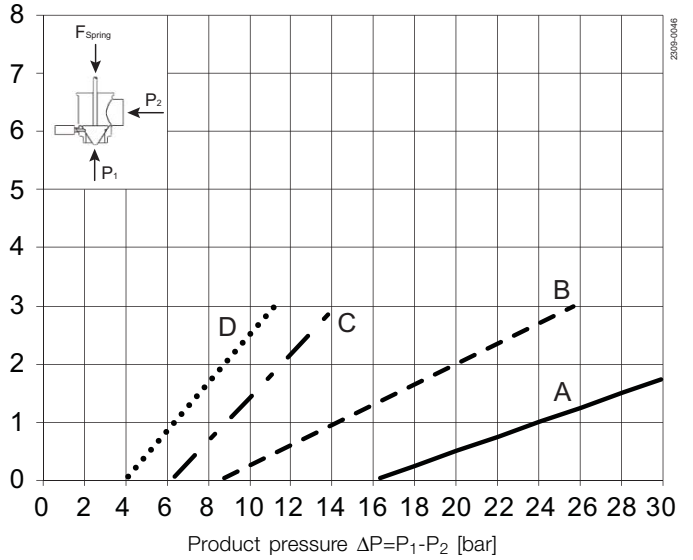

- A. DN40/DN50; ISO38/ISO51
- B. DN65; ISO63.5
- C. DN80; ISO76.1
- D. DN100; ISO101.6

ø133 actuator with strong spring

Support air P_{air} [bar]

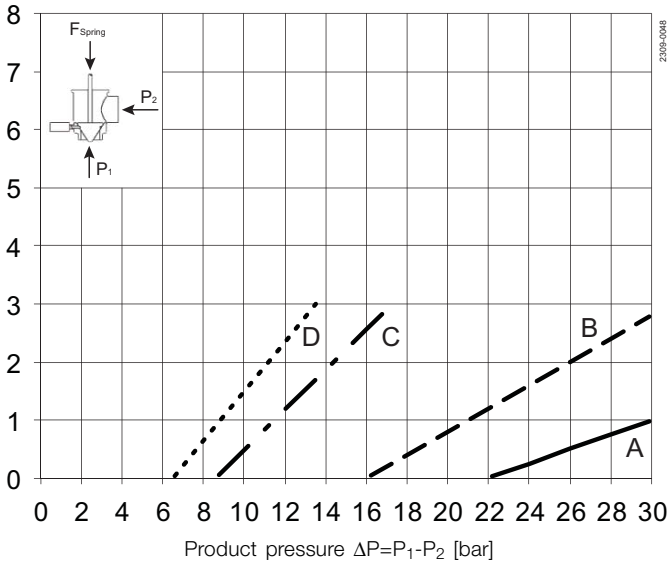

- A. DN40/DN50; ISO38/ISO51
- B. DN65; ISO63.5
- C. DN80; ISO76.1
- D. DN100; ISO101.6

Note: If actuator is supported by air on spring side; max allowable pressure is 300 kPa (3 bar)

Air reduction valve: Alfa Laval Item no. 9611995903 ensuring max. 3 bar support air

ø199 actuator

Support air P_{air} [bar]

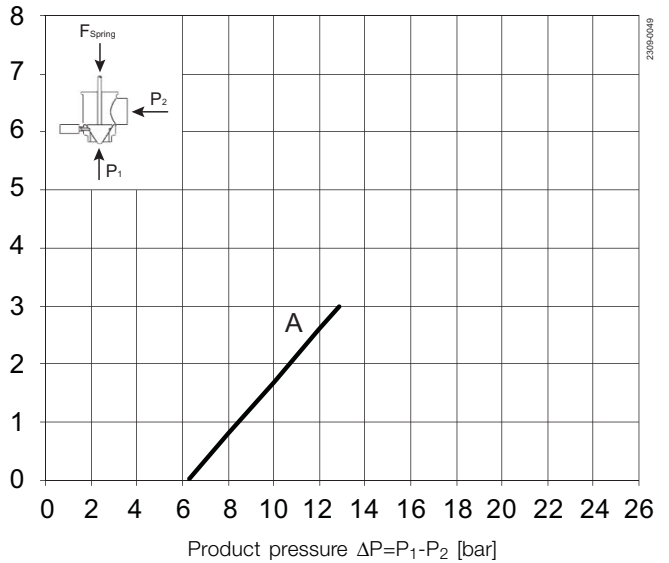

- A. DN125; DN150

Upper plug max. product pressure against which the valve can open, as a function of air pressure:

ø89 Actuator with standard spring

Air Pressure P_{air} [bar]

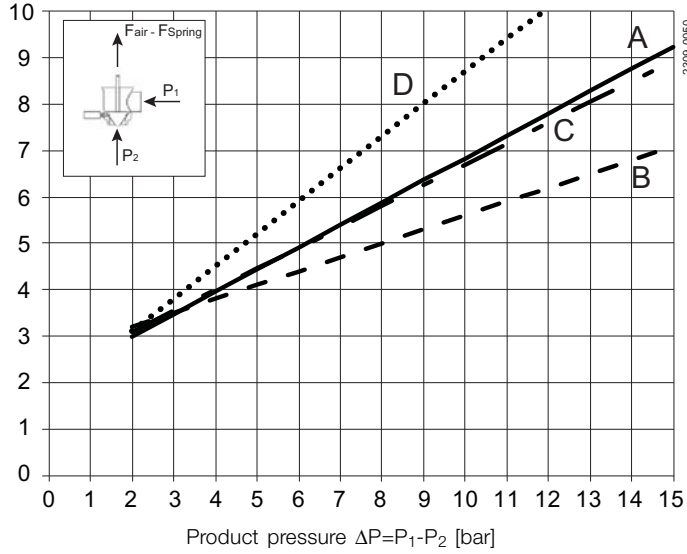

- A. DN40/DN50/DN80; ISO38/ISO51/76.1
- B. DN65; ISO63.5
- C. DN80; ISO76.1
- D. DN100; ISO101.6

ø89 actuator with strong spring

Air Pressure P_{air} [bar]

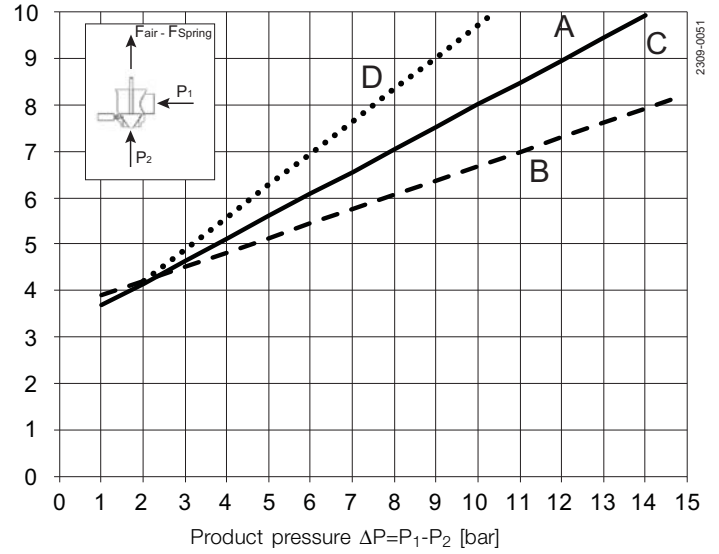

- A. DN40/DN50; ISO38/ISO51
- B. DN65; ISO63.5
- C. DN80; ISO76.1
- D. DN100; ISO101.6

ø133 actuator with standard spring

Air Pressure P_{air} [bar]

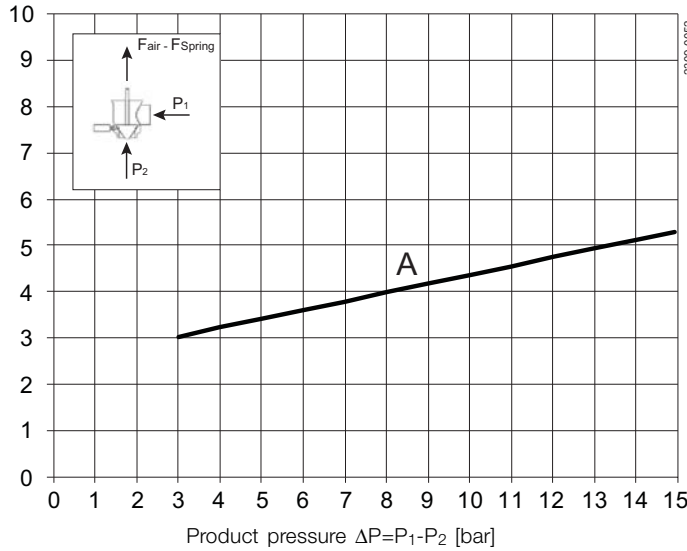

- A. DN40/DN50; ISO38/ISO51

ø133 actuator with strong spring

Air Pressure P_{air} [bar]

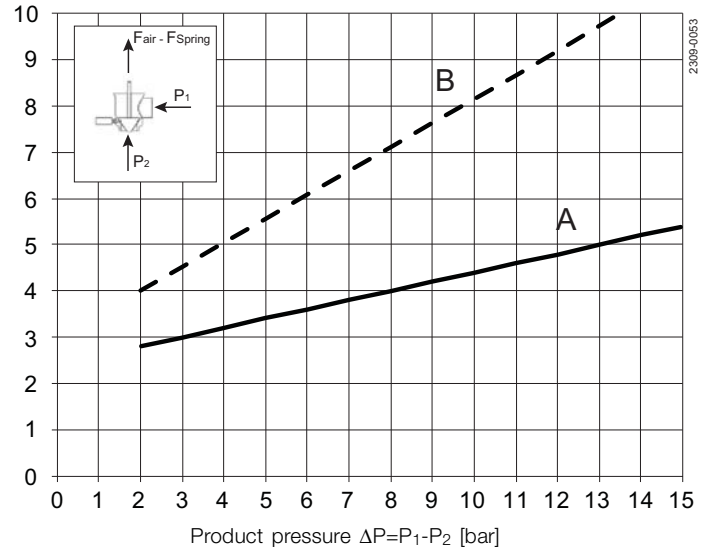

- A. DN40/DN50; ISO38/ISO51
- B. DN125; DN150

Note! If actuator is supported by air on spring side; max allowable pressure is 300 kPa (3 bar)

Air reduction valve: Alfa Laval item no. 9611995903 ensuring max 3 bar support air.

CIP/detecting valves. Max. product pressure without leakage, as a function of air pressure:

Support air P_{air} [bar]

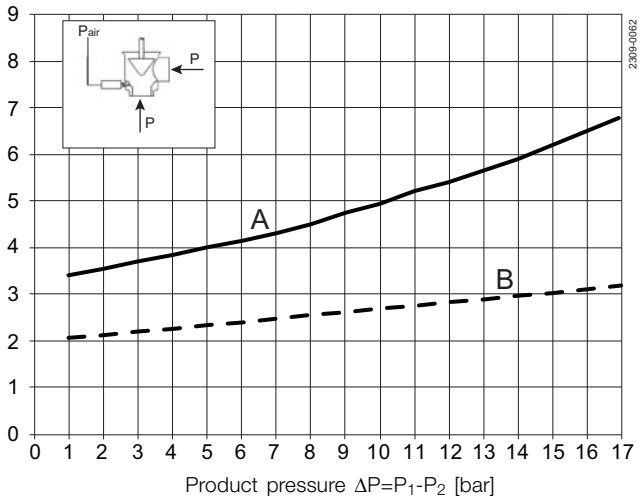

A. CIP valve $\varnothing 27$

B. CIP valve $\varnothing 32$

Max. CIP pressure in leakage chamber without leakage to product area, as a function of product pressure.

ø89 Actuator with standard spring

Product pressure $\Delta P = P_1 - P_2$ [bar]

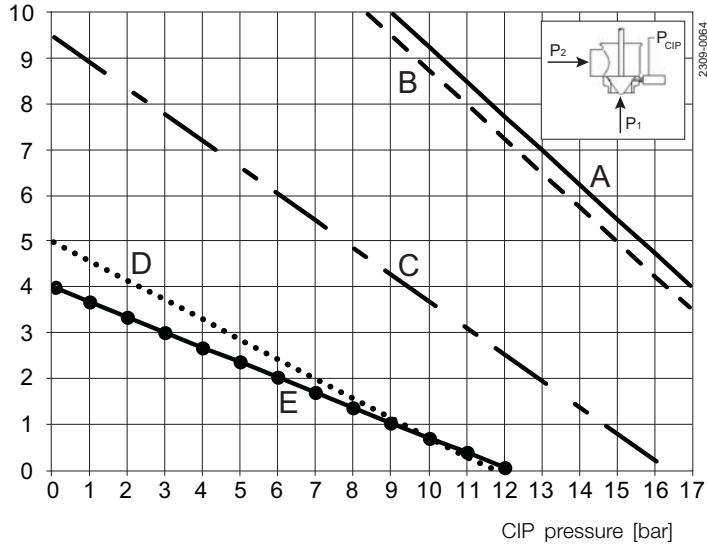

- A. DN40; ISO38
- B. DN50; ISO51
- C. DN65; ISO63.5
- D. DN80; ISO76.1
- E. DN100; ISO101.6

ø89 actuator with strong spring

Product pressure $\Delta P = P_1 - P_2$ [bar]

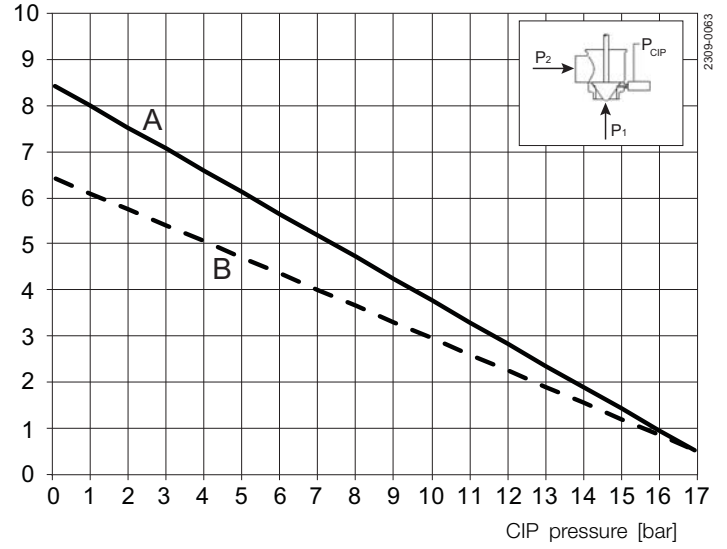

- A. DN80; ISO76.1
- B. DN100; ISO101.6

ø133 actuator with standard spring

Product pressure $\Delta P = P_1 - P_2$ [bar]

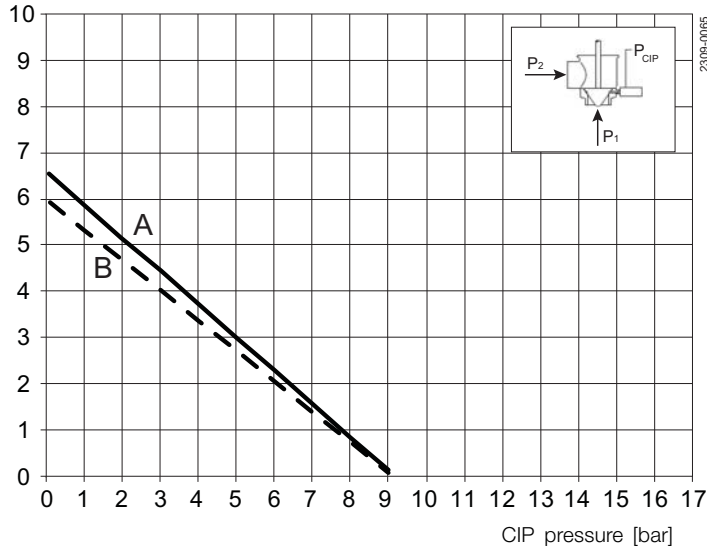

- A. DN40; ISO38
- B. DN50; ISO51

ø133 actuator with strong spring

Product pressure $\Delta P = P_1 - P_2$ [bar]

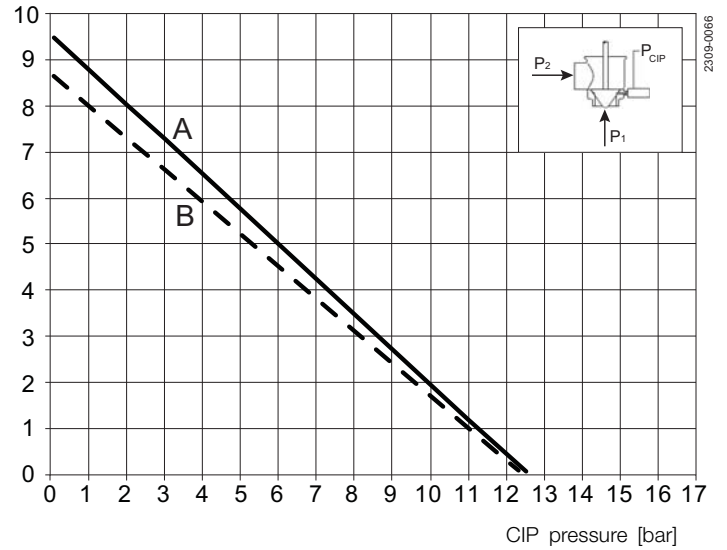

- A. DN40; ISO38
- B. DN50; ISO51

Note! If actuator is supported by air on spring side; max allowable pressure is 300 kPa (3 bar)

Dimensions (mm)

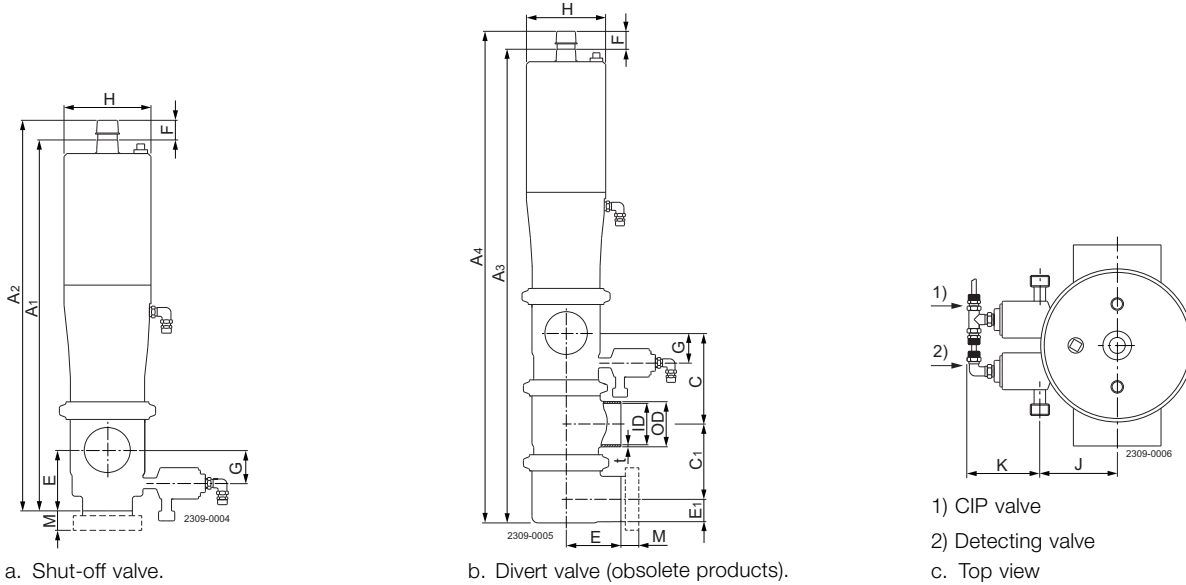

Size	38 mm	51 mm	63.5 mm	76.1 mm	101.6 mm	40 DN	50 DN	65 DN	80 DN	100 DN	125 DN	150 DN
A ₁	345	355	433	455	527	343	354	430	456	526	535	584
A ₂	370	380	458	487	559	368	379	455	488	558	580	629
A ₃	485.8	505.8	616.2	651.1	751.8	485	506	616	667	752		
A ₄	510.8	530.8	648.2	683.1	783.8	510	531	641	699	784		
C	90	102	124	129	157	90	102	124	134	157		
C ₁	80	84	108	115	150	80	84	108	120.5	150		
OD	38.1	50.8	63.5	76.1	101.6	41	53	70	85	104	129	154
ID	34.9	47.6	60.3	72.1	97.6	38	50	66	81	100	125	150
t	1.6	1.6	1.6	2.0	2.0	1.5	1.5	2.0	2.0	2.0	2.0	2.0
E	49.5	61.5	82.3	87.3	133.5	49.5	61.5	82.3	87.3	133.5	150	150
E ₁	20.5	26.8	33.2	39.1	51.8	22	28	36	43.5	53		
F	25	25	32	32	32	25	25	32	32	32	49	49
G	27	33.3	39.7	45.6	58.3	28.5	34.5	42.5	50	59.5	72	84.5
H	89	89	133	133	133	89	89	133	133	133	199	199
J	46.7	46.7	57	66.6	84.3	46.7	46.7	57	66.6	84.3	99.5	99.5
K	63	63	63	63	63	63	63	63	63	63	58.5	58.5
M/ISO clamp	21	21	21	21	21							
M/ISO male	21	21	21	21	21							
M/DIN male						22	23	25	25	30	46	50
M/SMS male	20	20	24	24	35							
M/BS male	22	22	22	22	27							
Weight (kg)												
Stop valve	6.0	6.3	12.8	13.3	16.6	6.0	6.3	12.8	14.0	16.6	43.4	44.5
Weight (kg)												
Change-over valve	7.7	8.1	15.0	17.0	23.0	7.7	8.1	15.0	18.0	23.0		

Air Connections Compressed air:

R 1/8" (BSP), internal thread.

CIP connection:

R 3/8" (BSP), external thread.

Leakage connection:

R 3/8" (BSP), external thread.

Caution, opening/closing time:

Opening/closing time will be affected by the following:

- The air supply (air pressure).
- The length and dimensions of the air hoses.
- Number of valves connected to the same air hose.
- Use of single solenoid valve for serial connected air actuator functions.
- Product pressure.

Alfa Laval reserves the right to change specifications without prior notification.

How to contact Alfa Laval

Contact details for all countries are continually updated on our website. Please visit www.alfalaval.com to access the information direct.