



Alfa Laval Unique Mixproof

Double seat valves

Introduction

The Alfa Laval Unique Mixproof Valve is a versatile, highly flexible double block-and-bleed valve for the safe and efficient management of fluids at intersection points in matrix piped systems. The valve enables the simultaneous flow of two different products or fluids through the same valve without the risk of cross-contamination. Modular design and a wide variety of options enable the valve to be customized to meet any process requirement—whether higher demands on cleanability and the ability to withstand pressure peaks.

Application

The Alfa Laval Unique Mixproof is designed for continuous flow management and process safety in hygienic processes where product safety is at the top of the agenda across the dairy, food, beverage and many other industries.

Benefits

- Enhanced product safety
- Cost-effective, spillage-free operation
- Optimized plant efficiency and enhanced cleanability
- Leakage detection and leakage chamber cleaning
- Fully configurable to fit your exact needs

Standard design

The Alfa Laval Unique Mixproof Valve is comprised of a series of base components, including valve body, valve plug, actuator, and cleaning options and accessories that support a wide range of applications. There are four pre-configured versions: the Unique Mixproof Basic; the Unique Mixproof SeatClean Valve; the Unique Mixproof HighClean Valve; and the Unique Mixproof UltraClean Valve. Leakage detection holes enable visual inspection without requiring valve disassembly and provide advance notification of parts wear. Few straightforward moveable parts contribute to reliable operation and reduced maintenance costs. The valve can also be fitted with the Alfa Laval ThinkTop V50 and V70 for sensing and control of the valve.



Working principle

The Alfa Laval Unique Mixproof Valve is a normally closed (NC) valve controlled from a remote location by means of compressed air. The valve has two independent plugs and seals to separate the liquids; the space between the seals forms a leakage chamber at atmospheric pressure during every working condition. Leakage rarely occurs but, should it occur, product flows into the leakage chamber and exits through the bottom outlet for easy detection.

When the valve is open, the leakage chamber is closed. The product then flows from one line to the other. The radial design of the valve ensures that virtually no product spillage occurs during valve operation. It is possible to adapt valve cleaning and water hammer protection to the requirements of individual process specifications.

TECHNICAL DATA

Pressure	
Max. product pressure:	1000 kPa (10 bar)
Min. product pressure:	Full vacuum
Air pressure:	Max. 800 kPa (8 bar)

Temperature	
Temperature range:	-5°C to +125°C (Depending on rubber quality)

PHYSICAL DATA

Materials	
Product wetted steel parts:	1.4404 (316L)
Other steel parts:	1.4301 (304)

Surface finish choose from the following:	
Internal/external semi-bright	Ra< 1.6µm
Internal Bright (polished)	Ra< 0.8µm
Internal/external Bright (polished)	Ra< 0.8µm

Note! The Ra values are only for the internal surface.

Product wetted seals:	EPDM
-----------------------	------

Other seals:	
CIP seals:	EPDM
Actuator seals:	NBR
Guide strips:	PTFE

Valve body combination

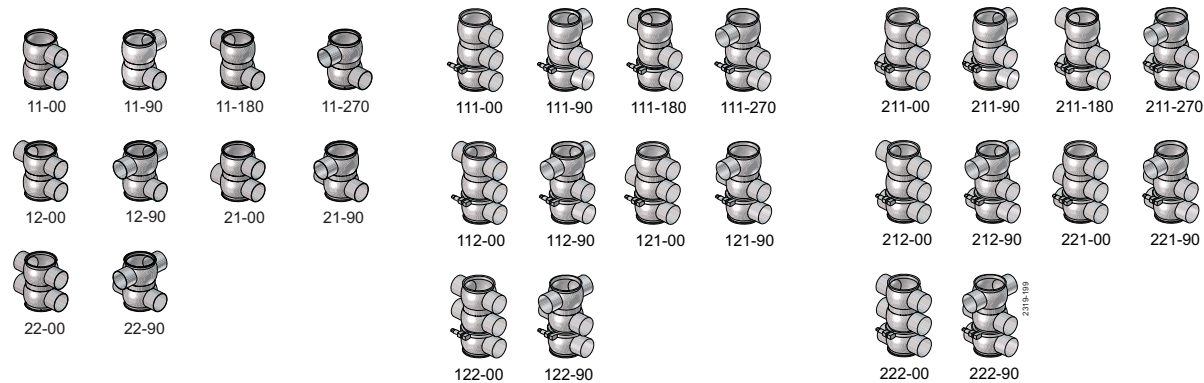

Valve body combinations, example: type 11-00

- 1 Number of ports - lower valve body
- 1 Number of ports - middle valve body
- 1 Number of ports - upper valve body
- 00 Angle between

SpiralClean

The Alfa Laval SpiralClean system to clean the upper and lower balanced plugs and leakage chamber. The system cleans more efficiently, uses less cleaning fluid by ensuring that a directional flow of CIP fluid reaches all the surfaces in much less time than with conventional systems.

Selection guide

The drawings below give an overview of all options when choosing the valve to fit your process, thus demonstrating the actual flexibility of the Unique Mixproof Valve.

Size flexibility

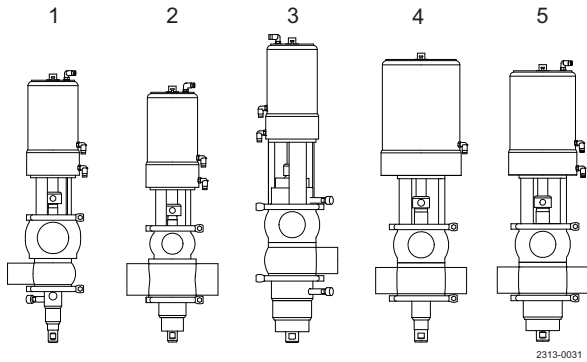

The Unique Mixproof concept offers balanced and unbalanced plugs, seat lift, CIP for the plugs and leakage chambers and any combination in between.

1. ISO 51 (2")/ISO 76.1 (3"), 11-90, with spiral clean on lower unbalanced plug, group 3 basic actuator incl. seat lift and seat push
2. ISO 76.1(3")/ISO 51 (2"), 22-90, with lower balanced plug, basic actuator incl. seat lift and seat push
3. ISO 76.1(3")/ISO 51 (2"), 22-90, with lower balanced plug, basic actuator incl. seat lift and seat push
4. ISO 63.5 (2½"), 22-90, with spiral clean on leakage chamber, unbalanced plugs, group 5 basic actuator
5. ISO 63.5 (2½"), 22-90, with lower balanced plug, group 4 basic actuator incl. seat lift and seat push

Balancing flexibility

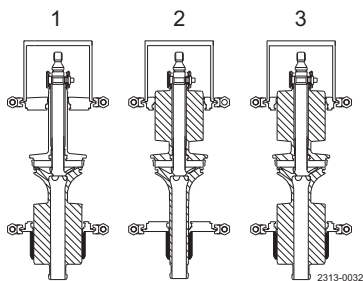

1. Lower balanced plug
2. Upper balanced plug
3. Upper and lower balanced plugs

Hygienic flexibility (spiral clean options)

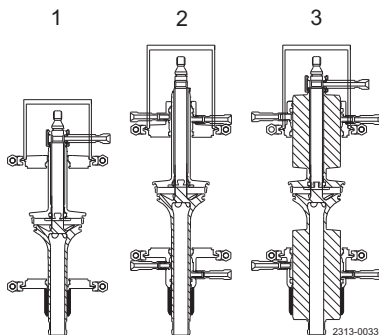

1. External CIP of leakage chamber
2. External CIP of upper and lower unbalanced plug
3. External CIP of leakage chamber upper and lower balanced plug

Standard configurations

To assist you in the selection we have included some standard configurations:

- Unique Basic
- Unique SeatClean
- Unique HighClean
- Unique UltraClean

You can either choose these directly or add additional features ensuring that the valve suits your specific needs.

Unique Basic has the basic components, providing significant safety and leakage detection.

- Actuator without seatlift.
- Unbalanced plugs.
- No SpiralClean of leakage chamber or plugs.
- Not applicable for 3-body version

Unique SeatClean meets the typical demands of a process valve in the food and drink industry.

- Actuator with seat lift integrated.
- Balanced lower plug, Unbalanced upper plug.

- No SpiralClean of leakage chamber or plugs.

Unique HighClean is sure to meet your processing needs when dealing with sticky products or if no recontamination can be accepted at all.

- Actuator without seatlift integrated.
- Balanced lower and upper plug.
- SpiralClean of leakage chamber as well as of upper and lower plug.
- Not applicable for 3-body version.

Unique UltraClean meets the highest demands for hygienic processing. It has:

- Actuator with seat lift integrated.
- Balanced lower and upper plug.
- SpiralClean of leakage chamber, upper and lower plug

Options

- Male parts or clamp liners in accordance with required standard.
- Control and Indication: IndiTop, ThinkTop or ThinkTop Basic.
- Side indication for detection of upper seat lift
- Product wetted seals in HNBR, NBR or FPM
- Various internal/external surface finish
- 3A (hygienic standard) on request
- Mixed housing (Not applicable for 3-body version)

Pressure drop/capacity diagrams

Example to determine pressure drop:

Upper body size:	DN/OD 51mm. Balanced upper plug. Capacity = 20 m ³ /h
Lower body size:	DN/OD 76.1mm. Balanced lower plug. Capacity = 20 m ³ /h
Between bodies:	Capacity = 15 m ³ /h

Result:

From fig. 3, $\Delta p = 7.5$ kPa through upper body.

From fig. 4, $\Delta p = 2$ kPa through lower body.

From fig. 5, $\Delta p = 14$ kPa seeing that:

1. The smallest body determines the curve for Δp between bodies.
2. Always choose the curve for balanced plugs if upper plug is balanced. If only lower plug is balanced, always choose the curve for unbalanced.

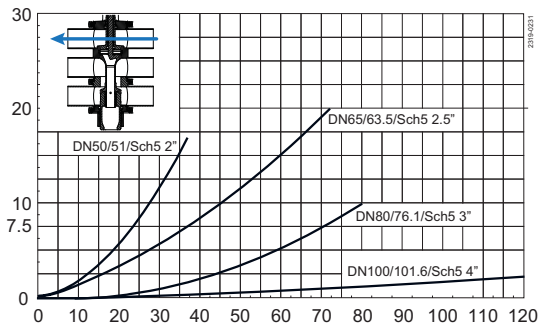

Fig. 3. Pressure drop/capacity diagram, upper body.

Full lines: Balanced upper plug.

Dotted lines: Unbalanced upper plug.

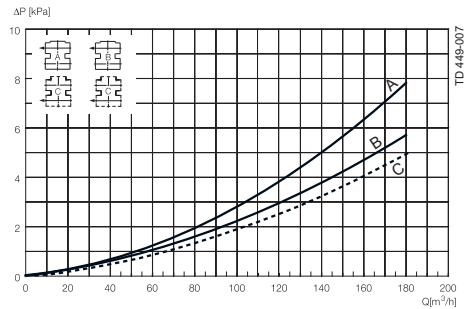

Fig. 6. Pressure drop/capacity diagram, through bodies DN 125, DN 150

A: Balanced upper plug

B: Unbalanced upper plug

C: Balanced and unbalanced lower plug

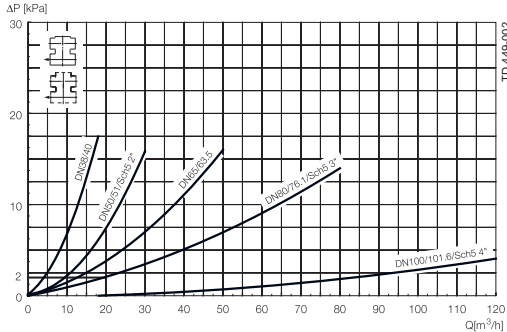

Fig. 4. Pressure drop/capacity diagram, lower body, balanced and unbalanced lower plugs.

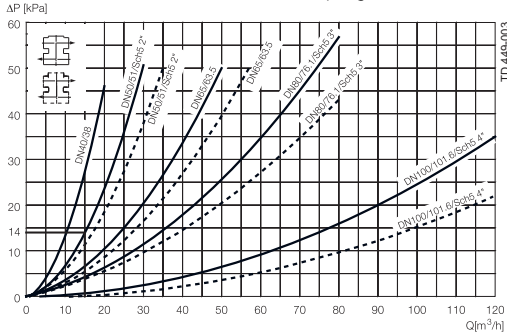

Fig. 5. Pressure drop/capacity diagram, between bodies.

Full lines: Balanced.

Dotted lines: Unbalanced.

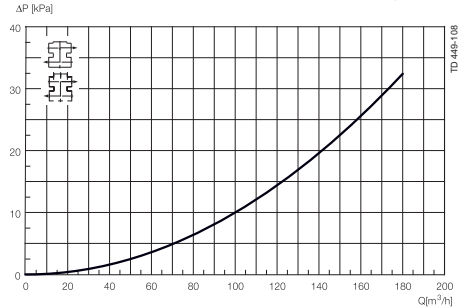

Fig. 7. Pressure drop/capacity diagram between bodies
Balanced and unbalanced plugs, DN 125, DN 150

Note! For the diagrams the following applies:

Medium: Water (20°C).

Measurement: In accordance with VDI 2173.

Pressure drop/capacity diagrams for 3 body valve

Between middle and lower body

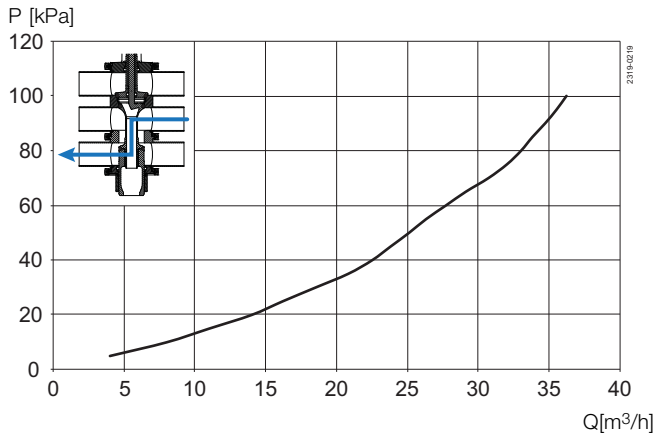

Between middle and upper body

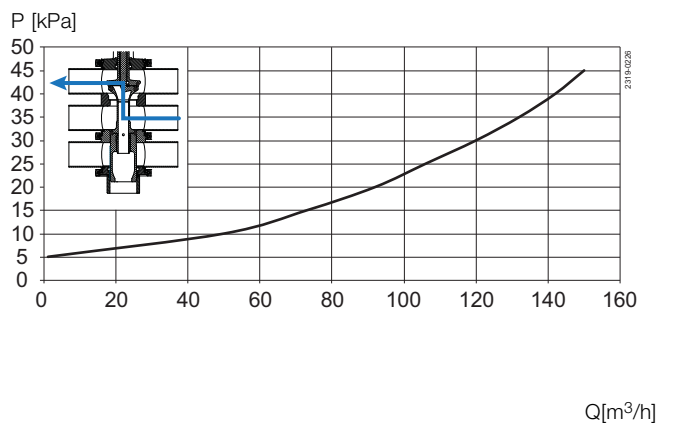
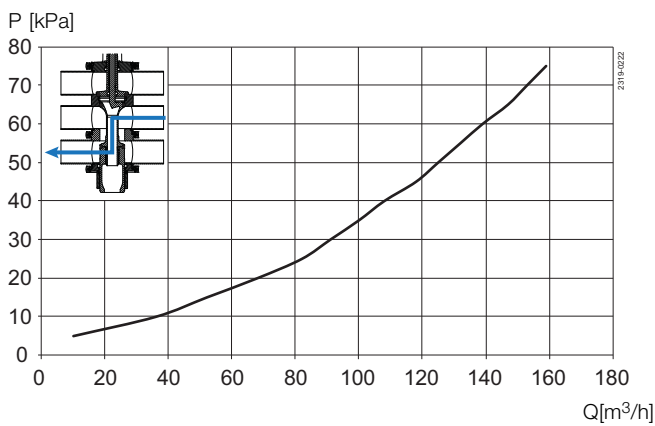
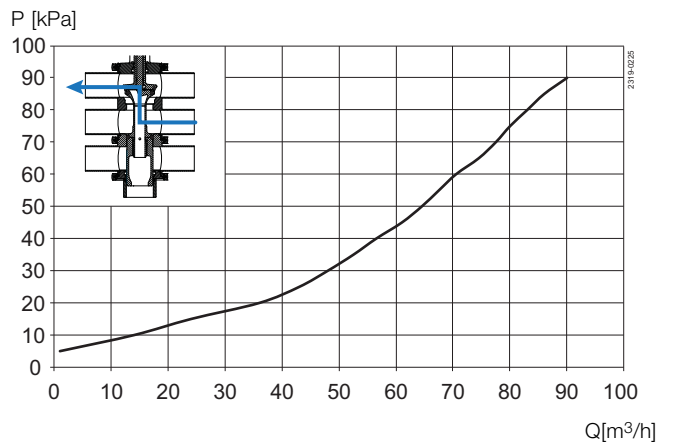
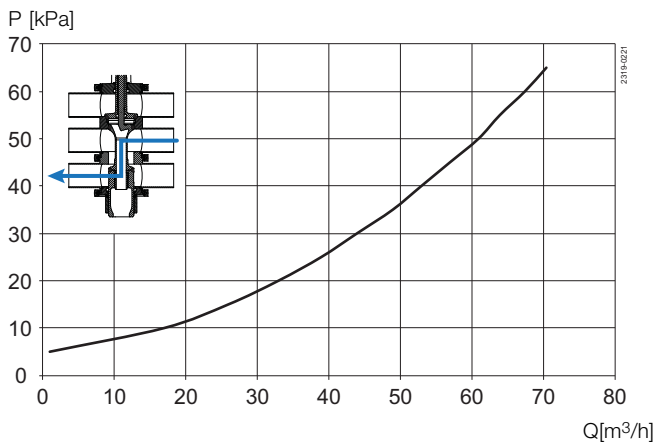
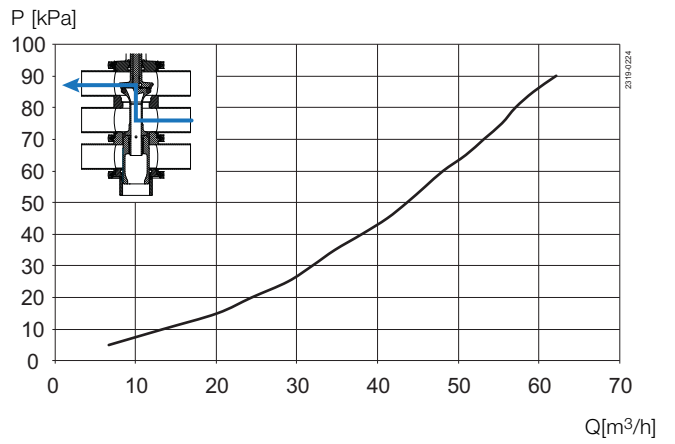
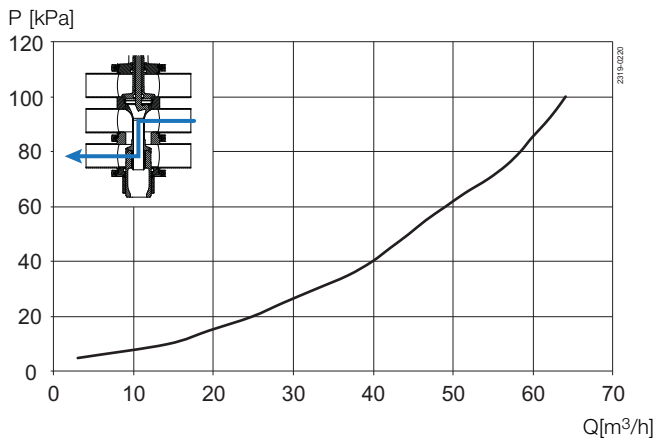
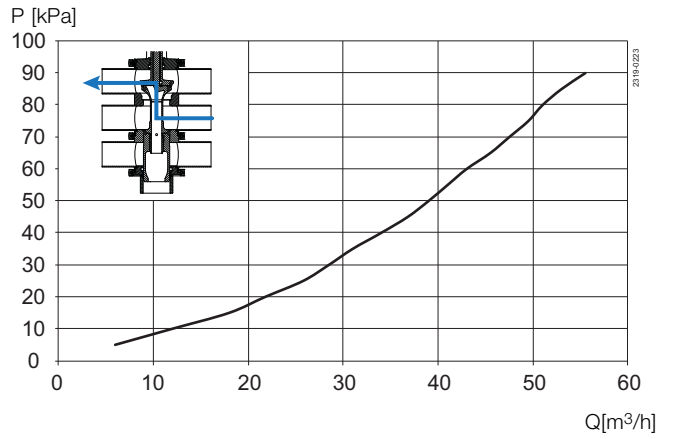

Middle body

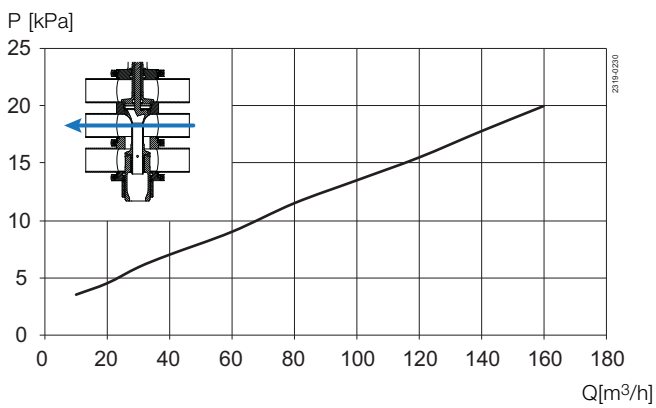
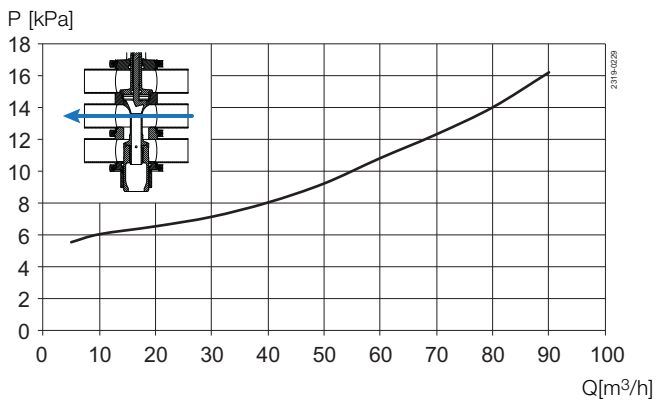
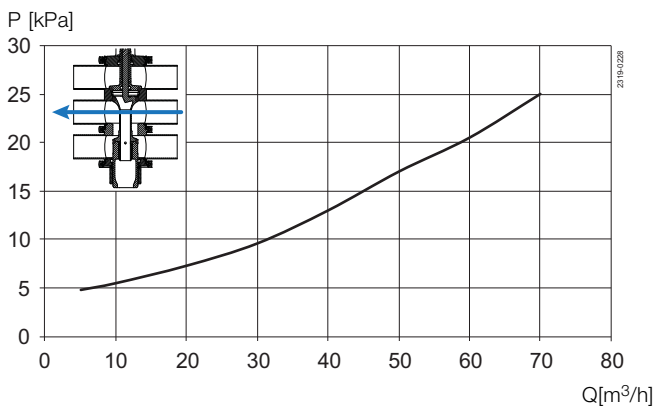
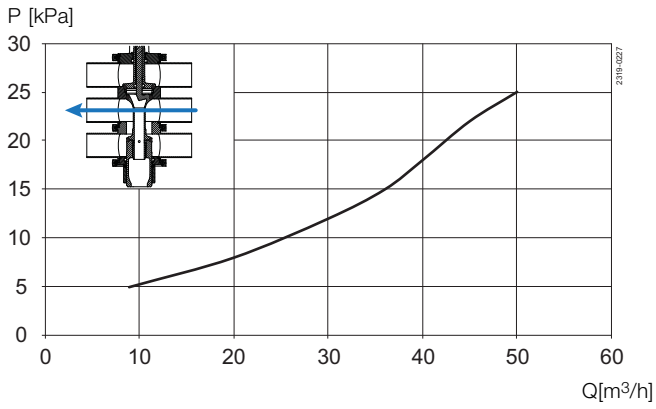

Air and CIP consumption

Size ISO/DIN	DN/OD						DN					
	38	51	63.5	76.1	101.6	40	50	65	80	100	125	150
Kv-value												
Upper Seat-lift [m ³ /h]	1.5	1.5	2.5	2.5	3.1	1.5	1.5	2.5	2.5	3.1	3.7	3.7
Lower Seat-lift [m ³ /h]	0.9	0.9	1.9	1.9	2.5	0.9	0.9	1.9	1.9	2.5	3.1	3.1
Air consumption												
Upper Seat-lift * [n litre]	0.2	0.2	0.4	0.4	0.62	0.2	0.2	0.4	0.4	0.62	0.62	0.62
Lower Seat-lift * [n litre]	1.1	1.1	0.13	0.13	0.21	1.1	1.1	0.13	0.13	0.21	0.21	0.21
Main Movement * [n litre]	0.86	0.86	1.63	1.63	2.79	0.86	0.86	1.62	1.62	2.79	2.79	2.79
Kv-value - SpiralClean												
Spindle CIP [m ³ /h]	0.12	0.12	0.12	0.12	0.12	0.12	0.12	0.12	0.12	0.12	0.12	0.12
External CIP of leakage chamber [m ³ /h]	0.25	0.25	0.29	0.29	0.29	0.25	0.25	0.29	0.29	0.29	0.29	0.29

TD900074-1

Note!

* [n litre] = volume at atmospheric pressure

Recommended min. pressure for SpiralClean: 2 bar.

Formula to estimate CIP flow during seat lift:

(for liquids with comparable viscosity and density to water):

$$Q = K_v \cdot \sqrt{\Delta p}$$

Q = CIP - flow (m³/h).

K_v = K_v value from the above table.

Δ p = CIP pressure (bar).

Actuator

Configurator Code (Ordering leaflet)	STD					STD/STD*		
	2	3	4	5	6	Operating pressure for Basic at 6 bar air pressure		
Actuator Type	3	4BS ¹	4SS ²	5BS	5SS			
Actuator dimensions øD x L	120 x 230	157 x 252	186 x 281	186 x 281	186 x 379			
Connection Size ISO (DN/OD)	DIN (DN)							
38	40	STD	OP			1000 kPa	600 kPa	
51	50	STD	OP	OP			1000 kPa	600 kPa
63.5	65	OP	STD	STD*	OP	OP	1000 kPa	600 kPa
76.1	80	OP	STD	STD*	OP	OP	1000 kPa	600 kPa
101.6	100		OP	OP	STD	STD*	1000 kPa	600 kPa
	125		OP	OP	STD	STD*	800 kPa	600 kPa

STD: Normal size of actuator

STD*: Normal size actuator if lower plug is UNBALANCED

OP: Alternative size of actuator (NB: For choice and performance of optional actuators please contact Alfa Laval or refer to the Anytime Configurator).

1 BS = Basic spring

2 SS = Strong spring

Radial Seat Diameter

ISO (DN/OD)	DIN (DN)	Seat
38	40	ø53.3
51	50	ø53.3
63.5	65	ø81.3
76.1	80	ø81.3
101.6	100	ø100.3
	125	ø115.3
	150	ø115.3

Dimensions (mm)

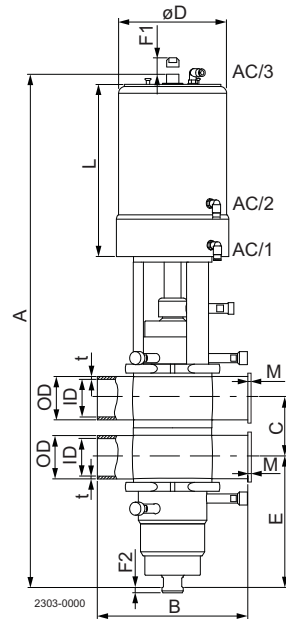

Note for mixed bodies

1. The seat always applies to the smallest valve body.
2. Dimension B is equal with the largest valve body size.

ISO/DIN	Size	DN/OD						DN					
		38	51	63.5	76.1	101.6	40	50	65	80	100	125	150
*A - BasicClean		530	575	699	699	899	530	575	699	699	899	993	993
*A - SeatClean		530	575	670	670	791	530	575	670	670	791	895	895
*A - HighClean + UltraClean		611	656	760	760	922	611	656	760	760	922	1026	1026
B		170	220	220	220	300	170	220	220	220	300	300	300
**C		60.8	73.8	86.3	98.9	123.6	64	76	92	107	126	151	176
OD		38	51	63.5	76.1	101.6	41	53	70	85	104	129	154
ID		34.8	47.8	60.3	72.9	97.6	38	50	66	81	100	125	150
t		1.6	1.6	1.6	1.6	2.0	1.5	1.5	2.0	2.0	2.0	2.0	2.0
E - Basic/SeatClean		100	121	149	142	177	99	119	146	138	176	215	202.5
E - HighClean/UltraClean		144	165	200	193	248	143	163	197	189	247	286	273.5
F1		31.5	31.5	38	38	59	31.5	31.5	38	38	59	59	59
F2		5	5	5	5	5	5	5	5	5	5	5	5
øD - Basic		120	120	186	186	186	120	120	186	186	186	186	186
øD - SeatClean, HighClean and UltraClean		120	120	157	157	186	120	120	157	157	186	186	186
L - Basic		230	230	281	281	379	230	230	281	281	379	379	379
L - SeatClean, HighClean and UltraClean		230	230	252	252	281	230	230	252	252	281	281	281
M/ISO clamp		21	21	21	21	21							
M/DIN clamp							21	21	21	21	21	28	28
M/ISO male		21	21	21	21	21							
M/DIN male							22	23	25	25	30	46	50
M/SMS male		20	20	24	24	35							
M/BS male		22	22	22	22	27							
Weight (kg) - Basic		13.5	15	24	24	34	13.5	15	24	24	34	44	45
Weight (kg) - SeatClean		13.5	15	24	24	34	13.5	15	24	24	34	47	48
Weight (kg) - High-/UltraClean		14.5	16	27	27	38	14.5	16	27	27	38	51	52

TD900074-1

Note! * For the A-measure if different upper/lower body sizes, please refer to Anytime configurator or contact Alfa Laval.

** The measure C can always be calculated by the formula $C = \frac{1}{2}ID_{upper} + \frac{1}{2}ID_{lower} + 26 \text{ mm}$.

Dimension for 3-body version

Group	3	4	4	5	3	4	4	5
Size	DN/OD	DN/OD	DN/OD	DN/OD	DN	DN	DN	DN
ISO-DIN	51	63.5	76.1	101.6	50	65	80	100
A - without Spiral Clean	615.6	714.65	728.45	877.2	615.6	714.7	744.7	877.3
A - with Spiral Clean	696.1	804.65	818.45	1008.2	696.1	804.7	834.7	1008.3
A - Flushed	611.2	706.75	726.25	872.7	615.6	714.7	744.7	877.3
B	220	220	220	300	220	220	220	300
**C	73.8	86.3	98.9	123.6	76	92	107	126
OD	51	63.5	76.1	101.6	53	70	85	104
ID	47.8	60.3	72.9	97.6	50	66	81	100
t	1.6	1.6	1.6	2	1.5	2	2	2
E - without Spiral Clean	86.7	107.5	102.4	139.5	83.4	99.0	106.5	136.0
E - with Spiral Clean	130.2	158.0	152.9	210.5	126.9	149.5	157.0	207.0
E - Flushed	82.3	99.6	100.2	135.0	83.4	99.0	106.5	136.0
F1	31.5	38	38	59	31.5	38	38	59
F2	5	5	5	5	5	5	5	5
øD	120	157	157	186	120	157	157	186
L	230	252	252	281	230	252	252	281
M/ISO clamp	21	21	21	21				
M/DIN clamp					21	21	21	21
M/ISO male	21	21	21	21				
M/DIN male					23	25	25	30
M/SMS male	20	24	24	35				
M/BS male	22	22	22	27				

Alfa Laval reserves the right to change specifications without prior notification.

How to contact Alfa Laval

Contact details for all countries
are continually updated on our website.
Please visit www.alfalaval.com to
access the information direct.